

## Combined dividing Curtain: S07604

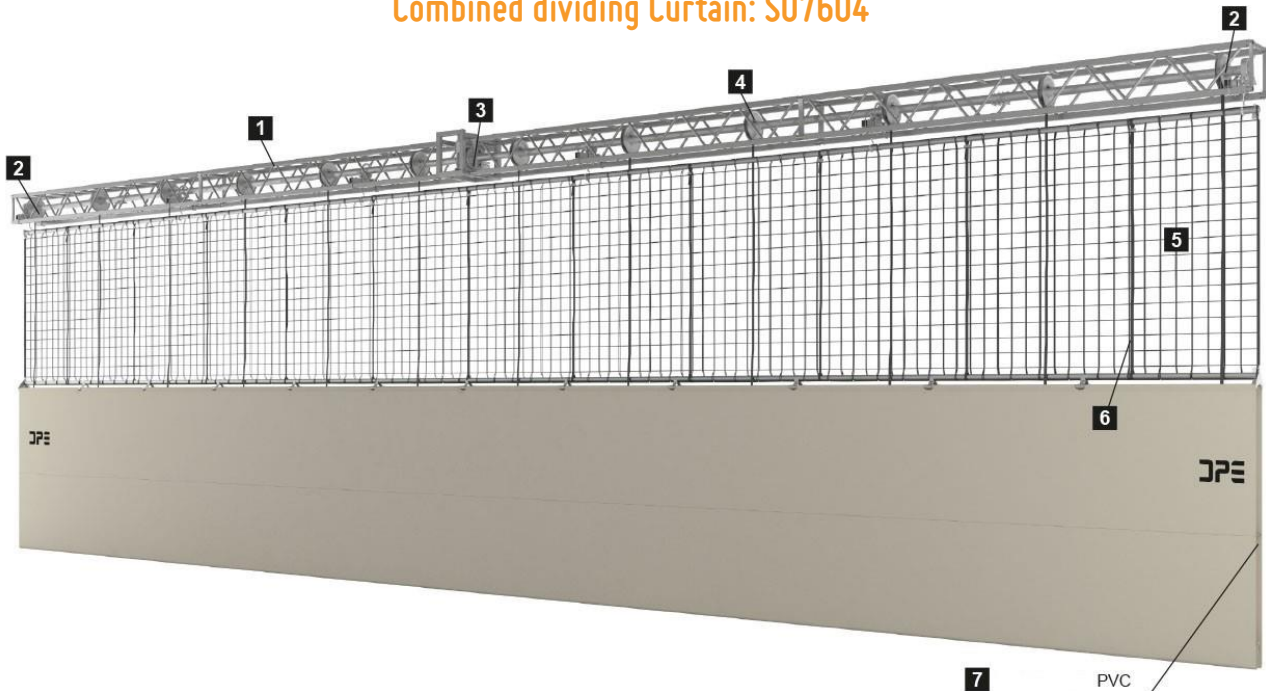

1

### CARRIER STRUCTURE – ALUMINIUM TRUSS

The aluminium truss 40 x 40cm is produced exclusively in the twist resistant version and with a thicker aluminium profile compared to the other structures.

A good behaviour under application of more important concentrated and distributed load is granted also for longer spans. The resistance to twisting is improved thanks to the new diagonal tubes design.

This truss is specially designed for dividing curtains. It allows to cover areas of small and large dimensions giving the chance to apply loads and keeping a perfect behaviour of the structure. In the aluminium truss the driving shaft with drive mechanism (engine, axle, bearings, supports, safety brakes) is incorporated with fixation elements.

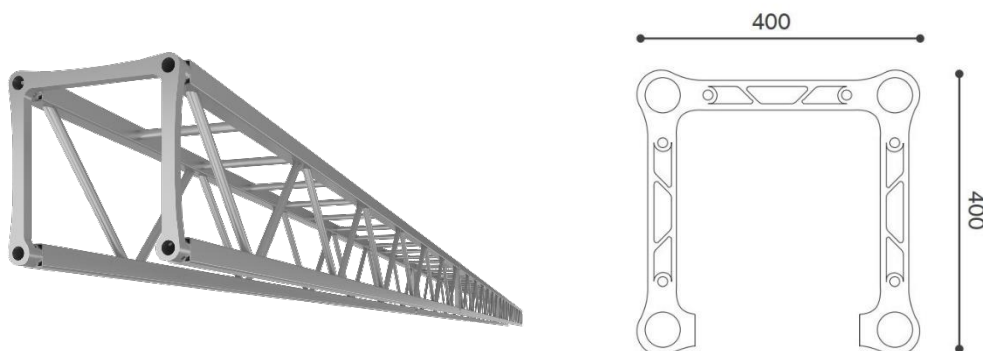

### Implementation of the construction

The holder segments are welded from aluminium profiles. Each segment consists of two bar sides, which are connected above to the transverse bars. The flanges of the sides are made of an aluminium square tube 50 x 50 x 3 mm. They are connected to each other by inclined bonds made of aluminium tube  $\phi$  25 x 2 mm. The upper bars are also made of aluminium tube  $\phi$  25 x 2 mm. At the ends of the segment, the end elements with prepared bearings for coupling cones are welded. The holder height is  $h = 350$  mm (flange axes) and width is  $b = 350$  mm (flange axes).

The suspension brackets are triangular, welded from three aluminium tubes  $\phi 25 \times 3$  mm. The lower corners are attached to the upper flanges of the holder. On the upper corner, the suspension bracket is connected with a chain on the arena metal construction.

The aluminium parts of the supporting construction are made of aluminium alloy EN-AW6060, and the steel elements are made of structural steel S 235 JR in accordance with standard EN 10025. The screws are of a strength class 8.8.

## Static Calculation

The supporting structure is calculated in accordance with Eurocode 9 and Eurocode 3 as well as DIN 18032-4. The load of the holder is the holder's empty weight and the weight of dividing curtain elements.

## Manufacture

The construction and its corrosion protection are made entirely in the workshop. Regulations on technical measures and conditions for installation of steel structures and Regulations on technical measures and conditions for corrosion protection of steel structures must be followed. This applies especially to corrosion protection film thickness (construction grade 3) and geometry tolerance. The colour shade of the stand (RAL) must be defined in the contract by customer.

## Colours

Standard colour is ALUMINIUM GREY. Other colours available on request.

## Certificates and approvals

Aluminium truss CE certificate.

## Flammability

Aluminium truss complies to A1 according to European Standard EN 13501-1 (non-combustible material).

2

## SAFETY BRAKE

Locking catch and locking wheel (triggering mechanism) trigger the braking action if the max. operation speed is exceeded. The special tooth geometry of the ratchet wheel reduces reaction time and thus the braking distance. The structure is only subject to extremely low braking moments.

Compact design, Visual indication of the triggering mechanism provided by a plunger (operating and braking position) Maintenance-free and self-controlling.

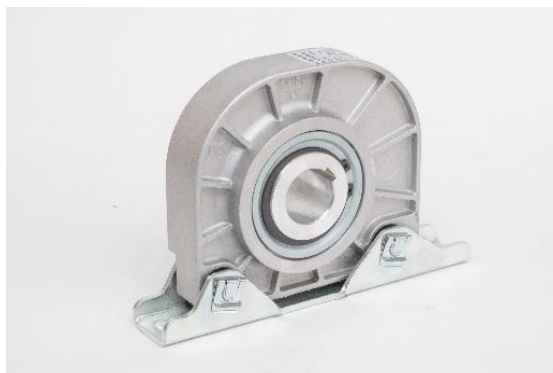

## Technical data FG 40

**Max. torque:** 400 Nm  
**Max. operating speed OPEN / CLOSE:** 45/24 rpm  
**Hollow-shaft:** 30 Ø mm  
**Locking torque:** 1150 Nm  
**Admissible bearing load Fmax:** 3000N  
**Temperature range:** -20 to +60 °C  
**Degree of protection:** IP65

## Technical dimensions

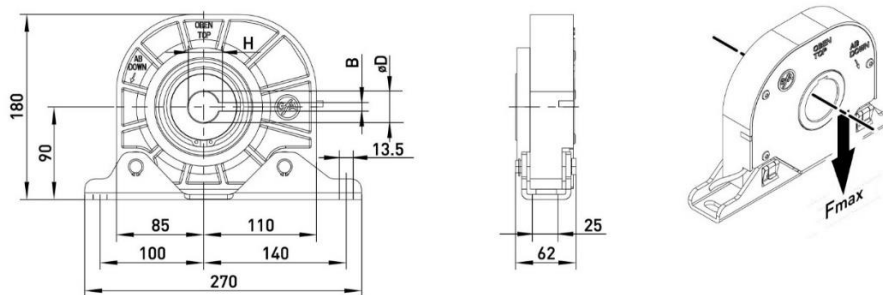

## Certificate

TÜV Certificate

## Other versions

Available

3

## DRIVE

DPE selection of special KE drives for dividing curtains.

The drive is driven directly from drive reducer shaft. Prevention of curtain falling back requires a safety brake of the appropriate size.

The drive consists of: worm gear, interchangeable output-shaft, emergency manual operator, integrated limit switches and electrical motor.



## Technical data KE 40

Output torque: 400Nm  
 Output turns: 20 min-1  
 Hollow shaft diameter: 40mm  
 Protection class: IP54  
 Temperature range: -8°C/+40°C  
 Supply voltage/frequency: 3X400V/50Hz(without N)  
 Max. cycles per hour: 6/h  
 Motor duty cycle: S3-60%  
 Motor power: 0,75 kW  
 Limit switch type/quantity: 6 mechanical limit switches  
 Limit switch range: E=60

## Technical dimensions

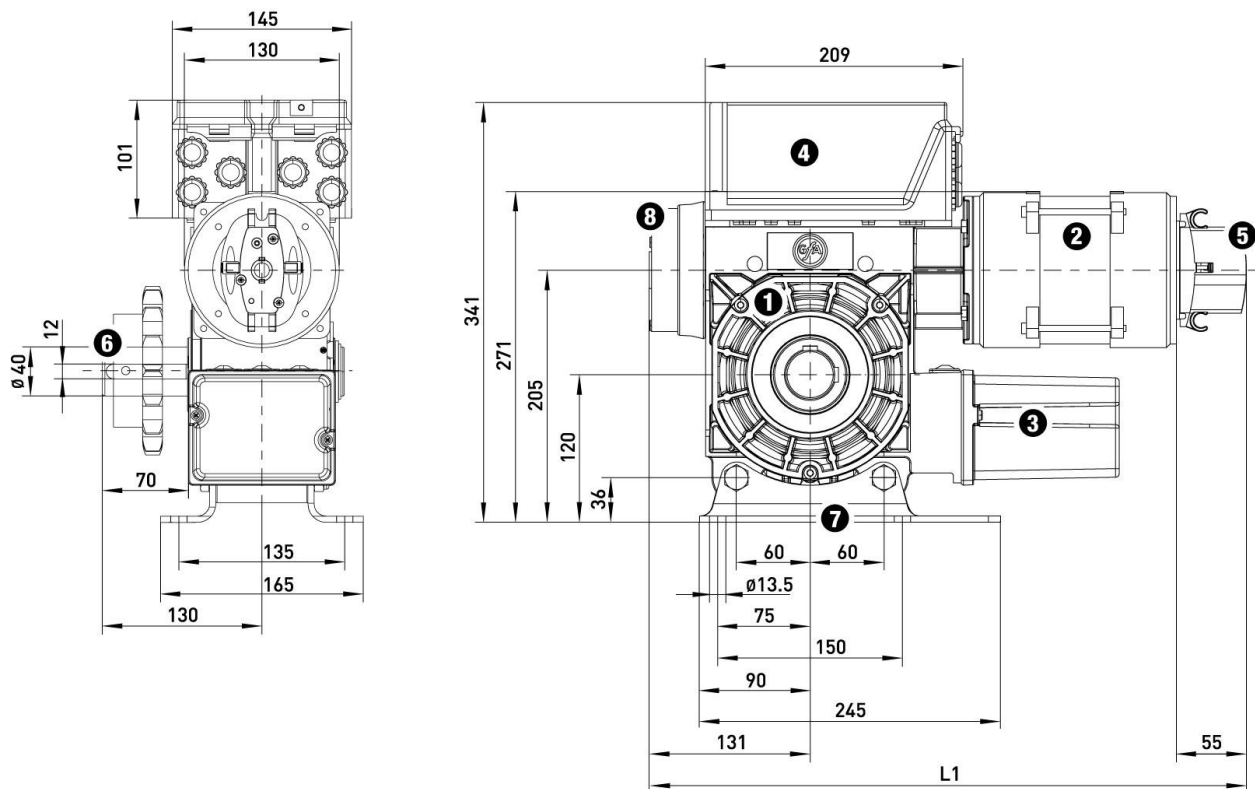

## Certificate

TÜV Certificate

## Other versions

Available for smaller/bigger versions.

## WINDING SYSTEM

Complete winding system (axle, bearings, junction elements, connection elements, pulleys, special shaped screws / hooks) together with drive and safety brakes is incorporated into aluminium truss.



Axle made of galvanized steel pipe

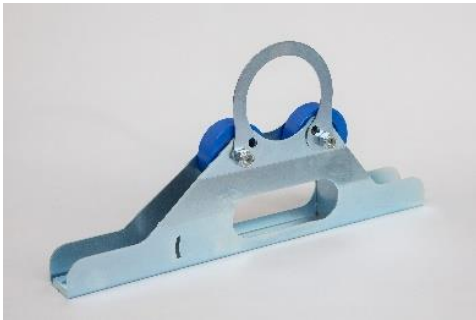

Bearing support with two rubberized wear resistant wheels and locking limiter made of laser cut steel plate.



Heavy duty junction element for axle junctions.



Heavy duty connection elements for drive and safety brake connection.



Pulleys for winding straps

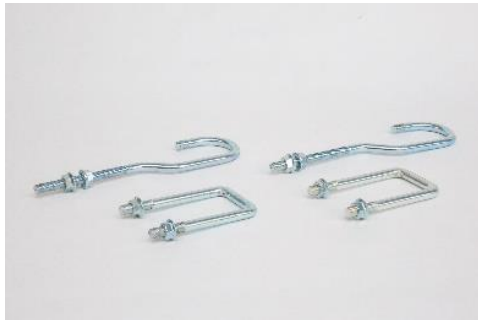

Special shaped screws / hooks.

## Surface treatment

All steel parts for winding system are galvanized.  
Other treatment (powder painting...) available on request.

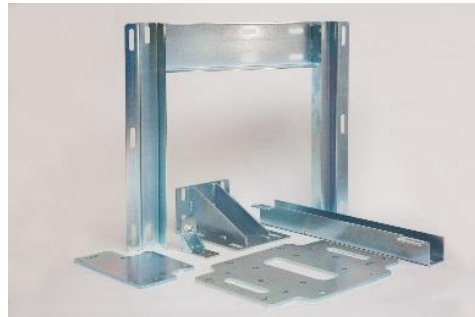
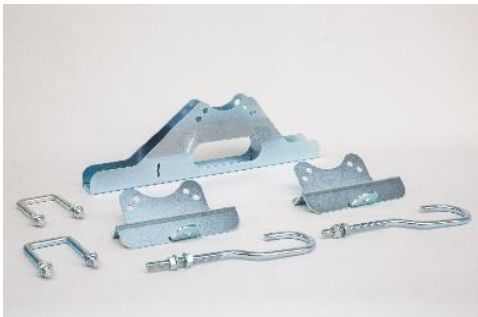

## Flammability

Metal parts comply to A1 according to European Standard EN 13501-1 (non-combustible material).

5

## NET

Special non knotted high-quality net to make a material with flat surface and great technical properties.  
Made from high tenacity material and highly resistant to abrasion and very light weight.

Knots are eliminated using a balanced knitted construction with filaments running continuously throughout the netting to enhance strength and durability.

The net is used in different square mesh variations (according to client's decision and wishes). Standard square mesh is 10 x 10 cm.



### Technical data

- Material: polypropylene HT
- Melting temperature: 174 C
- Net: knotless square mesh mm 100
- Weight: 57g per square meter
- Finish: sewn on perimeter plus reinforcement plait
- Breaking strength: 660 daN
- Extension: 913mm
- Total Energy: 1241 J
- UV resistant

### Colours

Standard colours: White or black.  
Other colours on request.

### Flammability

Net is **FR stabilized** by use of specialized FR master batch, at specific addition level, providing **B2** burning characteristics according to **EN 4102**.

### Other versions

Available on request.

6

## LIFTING STRAPS

Lifting straps are used for lifting/lowering the curtain. They have a high load-bearing capacity in terms of weight, are flexible at low temperatures, easy to use and handle, they consist of connecting elements with endless loops made of polyester, which are additionally protected.

### Technical data

- Without sharp corners and edges
- Weather resistant
- High resilience
- Thickness: 2mm
- Width: 25mm
- Weight: 37 gr/m<sup>2</sup>
- Resistance/strength: 2000 daN



### Colours

Standard colours: White or black.

7

## PVC - FABRIC

Our special PVC combines the latest weave technology with the usual high coating quality to make a material with a “unique” surface and outstanding technical properties. Perfect rolling characteristics is guaranteed. The low elongation levels on side elements under slight tension make this product range into a product with universal uses.

PVC is made especially for usage of Dividing curtains. It is unique and being produced exclusively.



### Technical data

- Type of coating: PVC
- Finish: textured surface
- Total weight\*: 1200 gr/m<sup>2</sup> according to EN ISO 2286-2
- Tensile strength (warp/weft): 1500 / 1500 N/50 mm according to EN ISO 1421/V1
- Tear strength (warp/weft): 300 / 300 N according to EN 53356
- Cold resistance: -10 °C according to EN 53361
- High temperature: +70 °C according to LB 3.15
- Base fabric, material: PES according to ISO 2076
- Yarn count: 1100 dtex according to ISO 2060
- Weave: M tex
- Complies with DIN 18032 part 4.2, materials

\*other weight and other versions available

### Material properties

- Flame retardant
- Optimum rolling characteristics
- High wind stability
- Bend resistant



### Other versions

Available.

## Standard Colours

Grey or Beige.



Others available on request.

## Flammability

According to EN 13501-1:

According to DIN 4102:

According to UNI 9177:

**B-s2,d0**

**B1**

**Classe 1**